



# FRIIA HCS

A stylish, flexible undercounter water range for higher-volume sites, such as hotels, cafes, or offices.

> Hot: 28 L/hr > Cold/Sparkling: 35-40 L/hr



## COMPLETE BUNDLE ORDER CODE

FRIIA HCS 1000865  
FRIIA HCS Plus 5000867

### 3B FONT 1000862



### CHILLER/ CARBONATOR 1000861



### MIX UC3 1000880



OR

### MIX UC8 1000887



### SYSTEM SET-UP

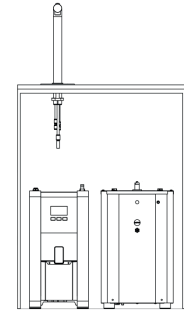

## CHILLER/CARBONATOR SPECS

PRODUCT INFO		SIZE	PERFORMANCE SPECS		PLUMBING, ELECTRICAL AND TECHNICAL SPECS				
NAME ORDER CODE	DIMENSIONS (D X W X H mm)		L/HR	CUPS /HR	POWER @220v	PLUMBING REQS	COMPRESSOR POWER	CHARGE	REFRIGERANT
Chiller/Carbonator 1000861	436 x 259 x 455		30-40l/hr based on incoming water temp of 15°C and output water temp of 5-7°	175-235 (ΔT = 10 °C)	180 W	3/4" BSP	1/8hp	45g	R290

A minimum operating pressure of 2 bar or 28 psi downstream of filter is required for optimum output l/min.

## BOILER SPECS

PRODUCT INFO		SIZE	PERFORMANCE SPECS			PLUMBING & ELECTRICAL REQ	
NAME ORDER CODE	DIMENSIONS (D X W X H mm)		IMMEDIATE DRAW OFF	L/HR	CUPS/HR	POWER @220v	PLUMBING REQS
MIX UC3 1000880	385 x 210 x 444		3L	28L	156	2.8kW	3/4" BSP
MIX UC8 1000887	385 x 210 x 617		8L				

## FONT SPECS

NAME ORDER CODE	DIMENSIONS INCL. DRIP TRAY (D X W X H mm)	DIMENSIONS EXCL. DRIP TRAY (D X W X H mm)	TAP TO COUNTER (mm)
3b Font 1000862	168 x 120 x 286	138 x 30 x 286	247

## PACKAGING

NAME	PACKAGING DIMENSIONS (L X W X H mm)	WEIGHT
Font	290 x 570 x 215	1.65kg
Chiller/Carbonator	500 x 320 x 520	35kg
MIX UC3	450 x 290 x 540	11kg
MIX UC8	450 x 290 x 700	14kg

## PLEASE NOTE

FRIIA components (font, boiler and chiller) are packed and shipped in individual boxes. FRIIA Sparkling variants require either an internal CO<sub>2</sub> canister (we recommend SodaStream 60L) or an external food grade CO<sub>2</sub> with regulator.

# FRIIA HOT/COLD/SPARKLING

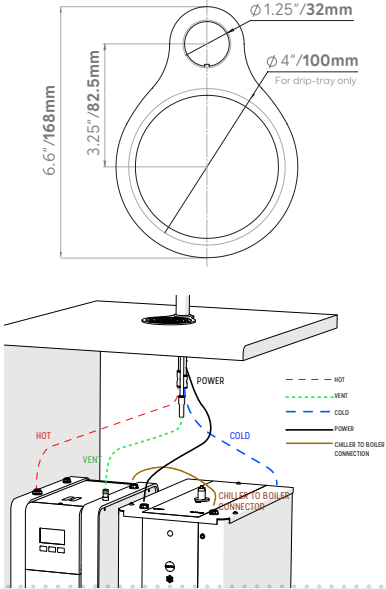
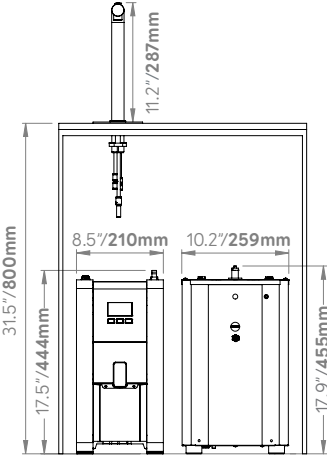
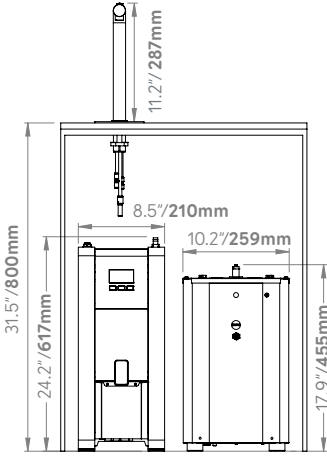
COUNTER CUT-OUT WITH DRIP TRAY	FRIIA HC 1000864 FRIIA HCS 1000865	FRIIA HC PLUS 1000866 FRIIA HCS PLUS 1000867
		
<h3>VENTILATION REQUIREMENTS</h3> <p><b>FRONT VENTILATION:</b> Ventilation grilles cut out of standard cabinet door.</p> <p><b>SIDE VENTILATION:</b> Ventilation grilles cut out of standard 600mm cabinet. Grilles may be fitted on either side as long as they ventilate into an open unobstructed area.</p> <p><b>BASE VENTILATION:</b> Ventilation grilles cut in base panel and base plinth, a grille must also be cut out at the top of the cabinet.</p> <ul style="list-style-type: none"> <li>&gt; At least 2 x vents 260mm/10.2" w x 65mm/2.5 h</li> <li>&gt; The cabinet may be ventilated in many ways provided there are cut outs placed near the base and another near the top of the cabinet to take advantage of natural circulation.</li> </ul>	<h3>PLUMBING INSTALLATION PROCEDURE</h3> <ul style="list-style-type: none"> <li>&gt; Ensure that the equipment is installed according to local plumbing &amp; water regulations.</li> <li>&gt; Fit a stop valve on a cold water line and attach a 3/4" BSP male fitting, (eg. 3/4" x 1/2" 311 or washing machine type stop valve). Suitable fittings are supplied with the kit to attach to the 3/4" BSP fitting to connect the supplied 3/8" hose.</li> <li>&gt; Connect water supply lines following the installation drawings, as per installation guide (starting page 14).</li> <li>&gt; In case filter systems are used verify that they satisfy the requirements of the legislation in force.</li> <li>&gt; If the filter is new, turn on water and flush at least 10 litres (2.5 gallon) through the filter before to connect it to the cooler; if the filter is a used one, connect water inlet to the chiller.</li> <li>&gt; To ensure that the maximum value of pressure of 3 Bar is not exceeded the chiller integrates a pressure reducer.</li> <li>&gt; Turn on the water to flush any impurities, dust etc from the inlet hose and water pipe. Allow several litres through. Especially for new installations.</li> </ul>	
<h3>UNPACKING INSTRUCTIONS</h3> <ul style="list-style-type: none"> <li>&gt; The chiller must be handled only in a vertical position. Transporting the appliance in a horizontal position can cause severe damage to the refrigerator.</li> <li>&gt; Remove the exterior and interior packing. Packing materials (especially any plastic bags) should be stored out of the reach of children, as a potential source of danger. When disposing packaging parts, please follow current regulations on the matter, separating carton from plastic parts.</li> <li>&gt; Always check that the equipment that is delivered corresponds to the model indicated in the accompanying document.</li> <li>&gt; The equipment is shipped in a cardboard box. Once the packaging has been removed, check the equipment has not been damaged in transit; if damage is found, notify the carrier.</li> </ul> <h3>ELECTRICAL INSTALLATION PROCEDURE</h3> <p>When installing the machine, always observe the local regulations and standards. The appliance is supplied with a moulded power cord. A suitable mains power supply socket should be available within easy access of the appliance so that it can be disconnected easily after install.</p> <p>The standard machines are supplied with a UK 3-pin plug. For EU models a 2-pin CEE-7 plug will be supplied. US models will be supplied with the suitable plug. A suitable mains power supply socket should be available within easy access of the appliance so that it can be disconnected easily after install. The wires from the front are terminated in a Mini Fit connector which will plug into a similar Mini Fit connector mounted on the top lid of the undercounter boiler.</p>	<h3>OPERATING THE CHILLER/CARBONATOR FOR THE FIRST TIME</h3> <ul style="list-style-type: none"> <li>&gt; Before connecting the appliance to the power source, let it stand upright for approximately 2 hours. This will reduce the possibility of a malfunction.</li> <li>&gt; Check that all installation procedures have been carried out.</li> <li>&gt; Ensure water inlet is open.</li> <li>&gt; Before supplying power to the unit check water and Carbon Dioxide lines do not leak.</li> <li>&gt; Plug the chiller into a suitable socket switch ON/OFF switch on the rear of the chiller to ON position. The "Power ON Status" light will light-up.</li> <li>&gt; When the unit is on, the carbonation pump starts to fill. The carbonation device stops when it reaches the maximum level.</li> <li>&gt; Once water and CO<sub>2</sub> are connected, open the vent on top of the Chiller by pulling the ring. This operation allows the escape of any air bubbles present inside, which would affect the carbonation adversely.</li> <li>&gt; On the pressure reducer knob, adjust CO<sub>2</sub> pressure to a value between 50 and 65 PSI (350 and 450 kPa) (3.5 - 4.5 bar). This value depends on the temperature of the water and on the ambient temperature. The temperatures correspond to the CO<sub>2</sub> pressure.</li> <li>&gt; To enable filling the lines, open the two lines in the following order: cold sparkling water and cold natural water, until the flows appear regular and without the presence of air, in each case deliver and discharge at least 5 litres of water from each line.</li> <li>&gt; At this point you can dispense water.</li> </ul>	

# FRIIA SYSTEM OVERVIEW

## COUNTER CUT-OUTS

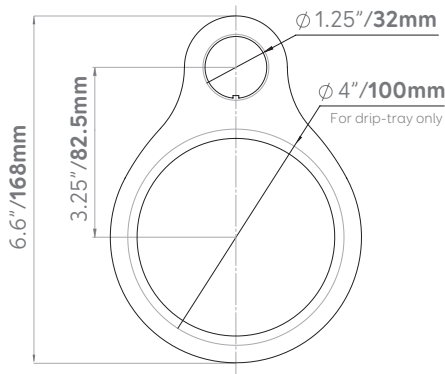

## RADIUS OF MAXIMUM FRONT PLACEMENT

Standard 800mm high cabinet

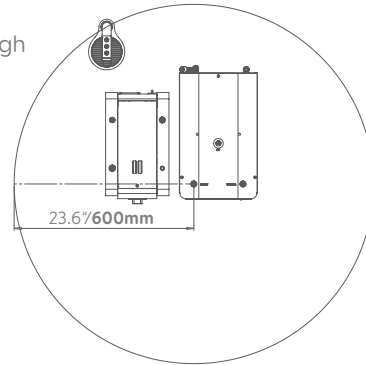

## CABINET

Min: 800mm (h) x 600mm (w) x 600mm (d) with 100mm clearance around machines all sides

## OPERATING ENVIRONMENT

Cannot exceed temperature of 35°C.

## VENTILATION

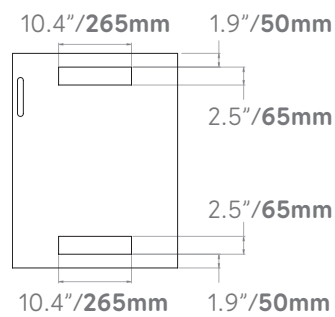
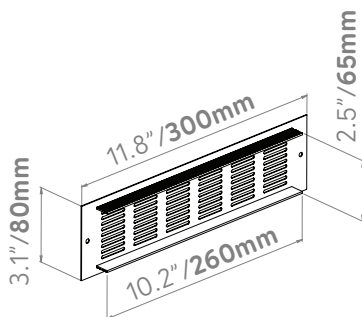
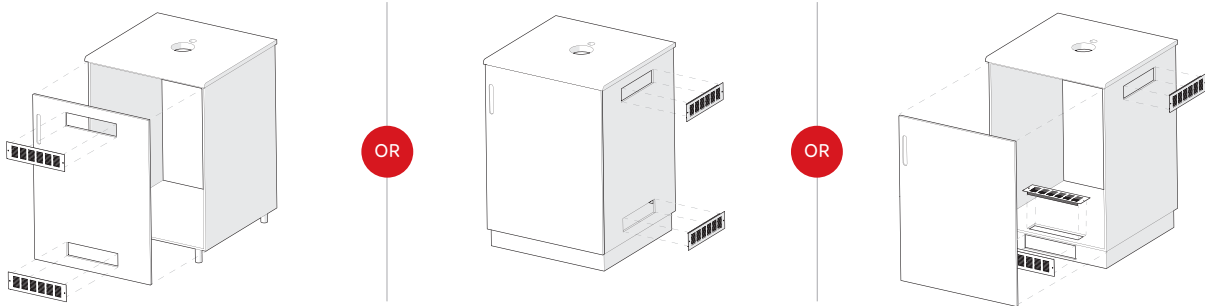

## PLEASE NOTE

It is essential to allow for two ventilation points when installing FRIIA. Vents are not supplied. Where possible, we recommend removing the back of your cabinet.



# FRIIA PERFORMANCE & MAINTENANCE

## FRIIA OUTPUT VOLUME

Based on flow rate of 1.4L/min and ambient temperature of 20-25°C. Chart indicates FRIIA chilling capacity based on incoming water temperature and desired output water temperature.

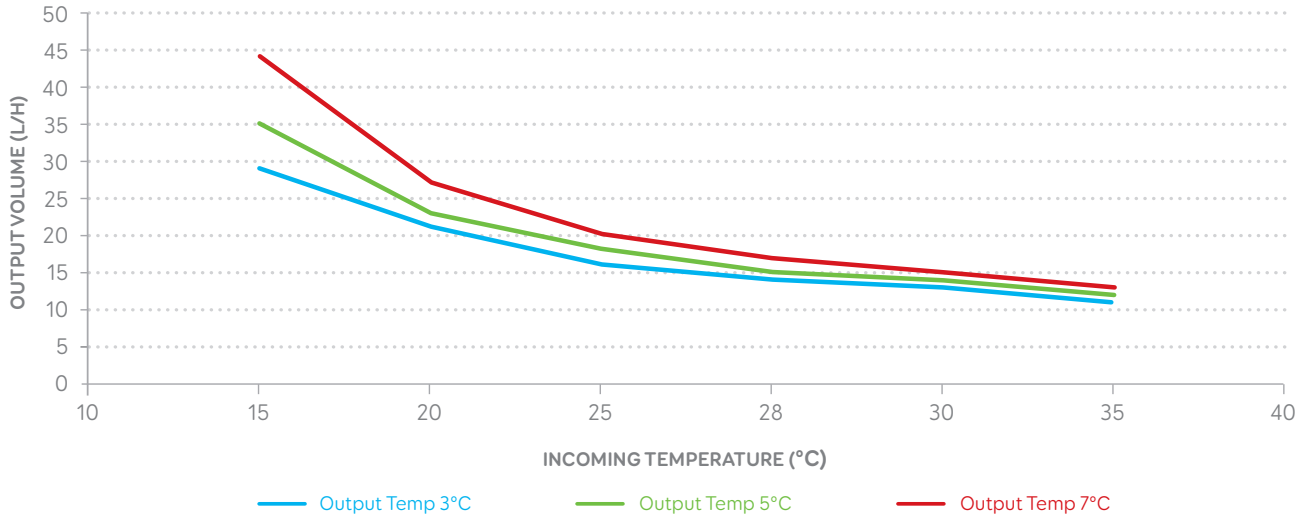

## SANITISATION ACCESSORIES

Sanitisation Kit: Internal Water Cooler Sanitising Solution 1L + Chiller Best Service Cartridge	8000900
Internal Water Cooler Sanitising Solution 1L	8800125
Scaleclean 1kg Descaler (5 uses)	8000260
Chiller Best Service Cartridge	8000522
Scaleclean 200g Descaler (1 use)	8000270

## HOW TO CLEAN FRIIA

- > Wipe down front daily with non-abrasive cleaner.
- > Sanitise the system every 6 months, after a filter change or after a period of inactivity (more than 72 hours)

## MAINTENANCE

- > We recommend use of both **HOT** (scale reducing filter if limescale is present) and **COLD** (carbon block for taste and odour) water filters for FRIIA. Please contact us for advice on the best water filter.
- > Descale the MIX boiler if scale is present in the water.